

# Electric Compact Pump ECP

For reliable lubrication of entry-level, single-line lubrication systems for oil and fluid grease



Oil or fluid grease



38 bar  
(552 psi)



+10 to 50 °C  
(+50 to 122 °F)



Small- to medium-sized  
machines

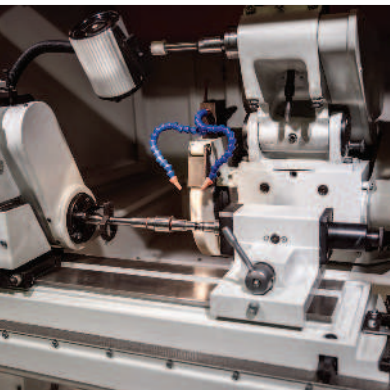

# Flexibility to meet your needs

The ECP is designed to lubricate bearings and linear guides with oil or fluid grease in systems of up to 20 lubrication points and a main line length of approximately 15 meters. It includes an integrated pressure-relief valve that enables its use in SKF single-line automatic lubrication systems. The ECP is available with pre-filled lubricant cartridges or with a choice of three sizes of plastic reservoirs for oil or fluid grease.

## Plastic reservoirs for easy refilling

Users preferring flexible reservoir sizes and easy refilling processes should select the ECP versions with transparent, plastic reservoirs.

To meet certain requirements, these reservoirs are offered with capacities of 0,5; 1,0 or 1,7 liters. Oil reservoirs include standard filling filters. Pump versions with reservoir capacities of 1,0 and 1,7 liters can be equipped with a fill-level monitor.

### Benefits:

- For either oil or fluid grease
- Reservoir offers flexibility and easy filling processes
- Different reservoir sizes available
- Extended maintenance and refilling intervals
- Venting necessary only during system start-up, not during reservoir refilling

## Pre-filled cartridges

To eliminate the risk of lubricant contamination, SKF recommends the ECP version that utilizes easy-to-exchange 380 ml cartridges. The cartridge pump version is available with an optional, integrated level switch to monitor fill level. The standard cartridge is pre-filled with fluid grease type 00.

### Benefits:

- Minimized risk of using wrong or contaminated lubricant
- Increased safety and cleaner work environment, less lubricant spillage on the floor
- Inventory management can be rationalized and simplified
- Safe and clean cartridge exchange without removing cap
- Standard cartridge filling with SKF-recommended fluid grease, other lubricants can be provided on demand

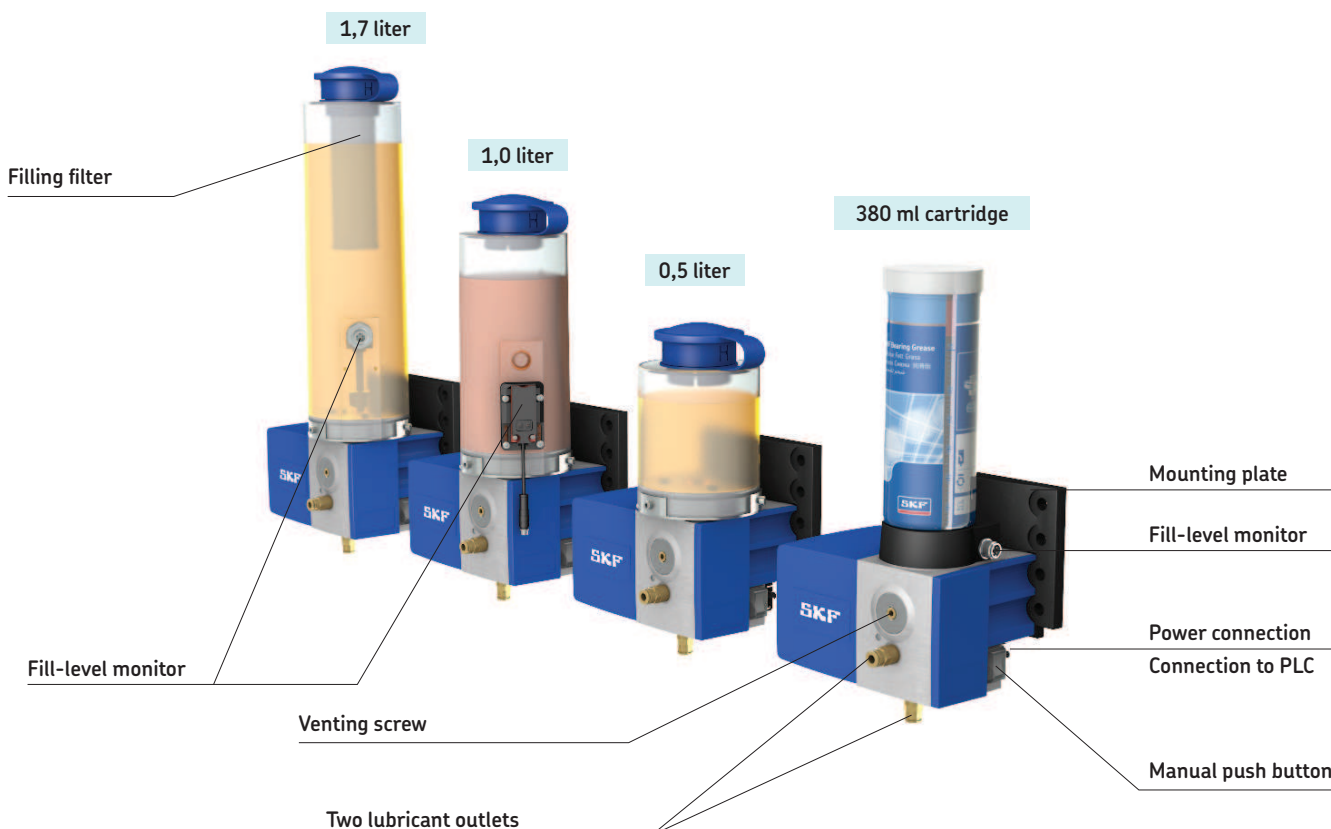

# Cost-effective and reliable solution

Setting new standards in design and flexibility, the ECP is a cost-effective and simple-to-operate lubrication pump. It is designed for use with SKF single-line metering devices in small- to medium-sized machinery.

## Control and monitoring options

Independent from the utilized reservoir, the ECP operates at 24 V DC and can be controlled by an external programmable logic controller (PLC) for convenience. In addition, the pump is capable of manually activating a lubrication cycle.

An easy-to-access venting screw enables simple installation and operational start-up.

## Features:

- Optional reservoir or cartridge
- Up to 2 lubricant outlets
- Fill-level monitoring with pre-warning functionality
- Operating voltage 24 V DC
- Controllable by external PLC
- Six optional mounting bores offer variety of installation possibilities
- Manual lubrication push button for easy system start-up or venting
- Venting screw for simple venting during system start-up or after cartridge exchange
- For indoor use

## Benefits:

- Cost-effective, reliable solution
- Simple to operate
- Extended lifetime of bearings and linear guides
- Increased machine uptime
- Precise and reliable system performance
- System can be expanded with more lubrication points, considering limitations of the system design

## Applications:

- Automation
- Machine tools
- Material handling
- Plastic-injection-molding machinery and processes

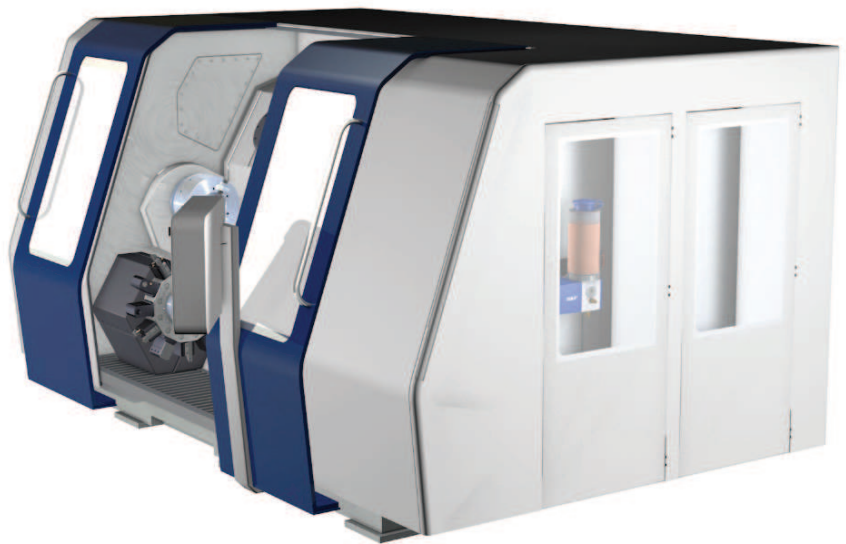

# Technical data

# Accessories

<b>Operating pressure</b>	max. 38 bar	max. 552 psi
<b>Operating temperature</b>	+10 to +50 °C	50 to 122 °F
<b>Delivery volume</b>		
Fluid grease	10 cm <sup>3</sup> /min	0.61 in. <sup>3</sup> /min
Oil	0,01 l/min	0.021 fl.oz./min
<b>Operating voltage</b>	24 V DC	
<b>Protection class</b>	IP 54	
<b>Number of outlets</b>	1 or 2 (front and/or bottom)	
<b>Lubricants</b>		
Oil	Viscosity 20 to 1 500 mm <sup>2</sup> /s (cSt)	
Fluid grease	NLGI 00, 000	
SKF standard cartridge fluid grease	Zeller+Gmelin Divinol Fluid Grease Type 00 work stable lithium soap lubricating grease, based on synthetic ester water resistant; oxidation and corrosion resistant	
<b>Capacity of the</b>		
Cartridges	380 ml	12.8 fl.oz.
Plastic reservoirs	0,5; 1,0; 1,7 l	1.06; 2.1; 3.6 fl.pt.
<b>Mounting position</b>	upright	

<b>Pre-filled standard cartridge, 380 ml</b>		
Lubricant	Zeller Gmelin Divinol Lithogrease 00	Package Order code
		10 pcs LF001/MR380
<b>Main line connectors</b>		
Connection thread M10x1		898-110-120
Quick connector Ø6 mm		406-004-VS
Banjo fitting Ø6 mm		506-140-VS
Quick connector Ø8 mm		408-0074-VS
Closing plug		466-431-001
<b>Electrical connectors</b>		
Rectangular connectors acc. to DIN EN175301-803-A		179-990-033 / -147
Circular plug M12x1, straight acc. to DIN EN61076-2-101		179-990-371 / -381
Circular plug M12x1, angled acc. to DIN EN61076-2-101		179-990-372 / -382
Wall bracket		995-901-065
Spare parts kit of gasket, adhesive		541-34901-5
Closure screw (ECP cartridge port)		541-34901-4
<b>Pressure-relief valves 60 bar for use in main line</b>		
Pressure-relief valve Ø6 mm		451-006-060
Pressure-relief valve Ø8 mm		451-008-060

## Dimensional drawing

### Minimum mounting dimensions:

Height: A-1 = 440 mm  
 A-2 = pump height plus 100 mm  
 Width: B = 240 mm  
 Depth: C = 210 mm

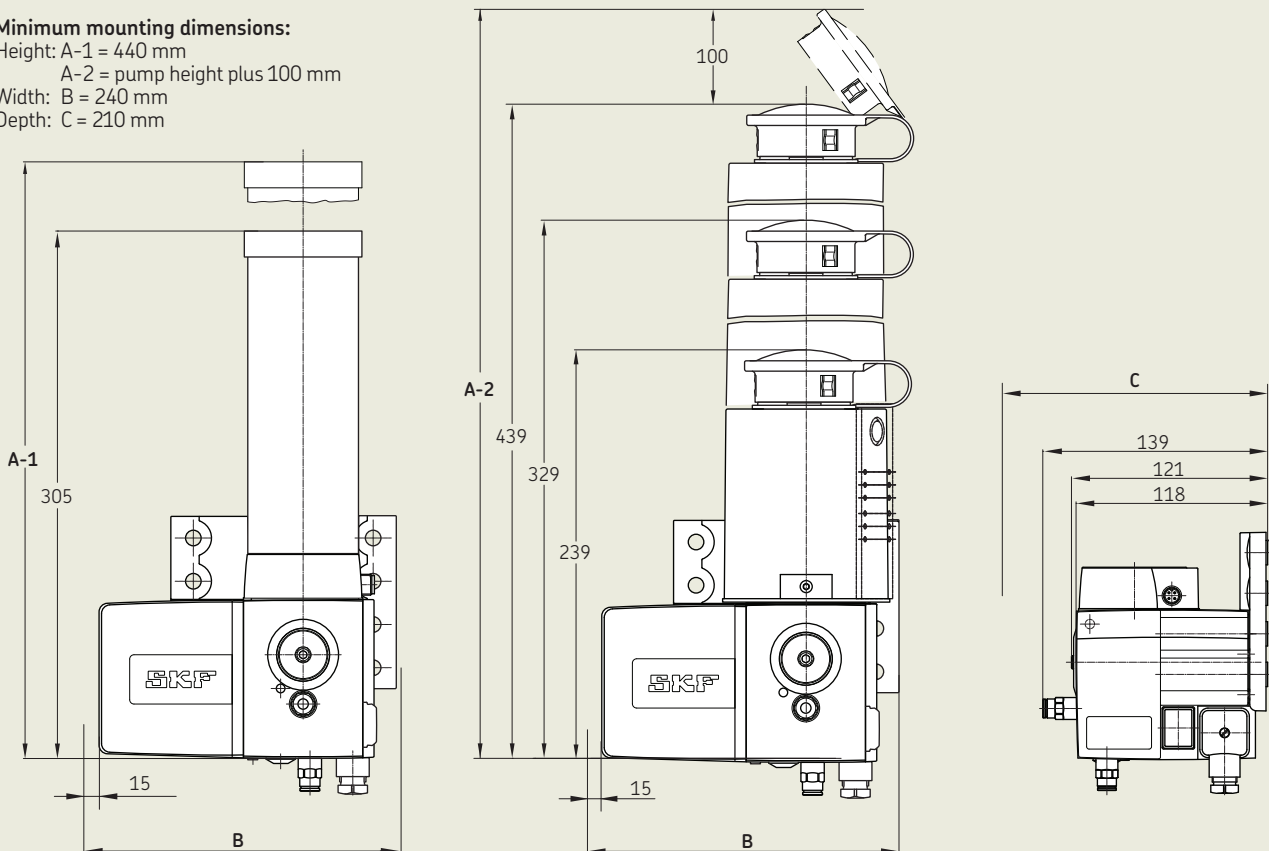

# How to order

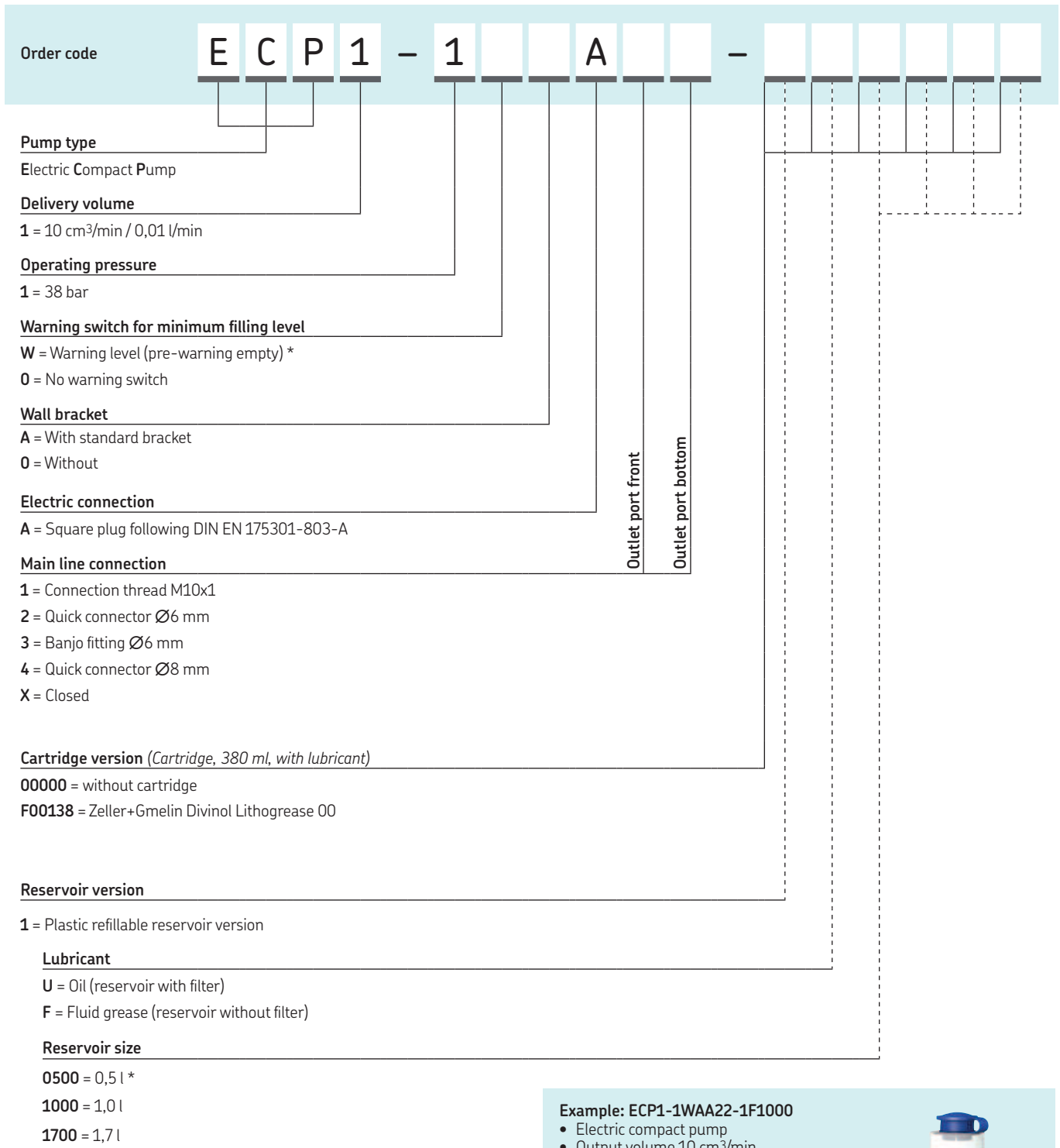

Outlet port front  
Outlet port bottom

\* **NOTE:** The 0,5 liter version can not be ordered with warning switch and/or oil filling filter.

**Example: ECP1-1WAA22-1F1000**

- Electric compact pump
- Output volume 10 cm<sup>3</sup>/min
- Operating pressure 38 bar
- With warning switch (1)
- With standard wall bracket (2)
- With electric connector square plug (3)
- With quick connector Ø6 mm, front (4)
- With quick connector Ø6 mm, bottom (5)
- Reservoir version
- Fluid grease
- 1,0 liter reservoir

# ECP and series 310 metering devices make ideal pair

The compact, electrically driven pump ECP, combined with the industry's first non-metallic metering device, offers you an efficient, reliable and flexible single-line lubrication system that is adjustable to your needs. Both the pump and metering device are designed to operate together in one system.

## Entry-level, single-line system

This entry-level system reliably supplies oil or fluid grease to bearings and linear guides.

Combining the different reservoir variants of the ECP pump with SKF's precise 310 metering devices provides you with maximum flexibility and cost efficiency.

The non-metallic metering device series 310 is simple to install utilizing plastic or metallic lines and can be mounted in either an upright or inverted position. It also features easily identifiable dosing elements to meet various lubrication requirements.

## Reliable operation

Single-line lubrication systems with ECP pumps and 310 metering devices operate within a wide temperature range and at a pressure of 38 bar (552 psi), supporting a minimum lubrication interval of 10 minutes and a main line length of 15 meters\*.

These systems are suitable for indoor use on small- to medium-sized machines with a maximum of 20 lubrication points\*.

\* Maximum main line length and number of lubrication points depend on the application and environment. Please contact your SKF partner for more information.



Oil or fluid grease



Minimum lubrication interval 10 minutes



Maximum main line length 15 m

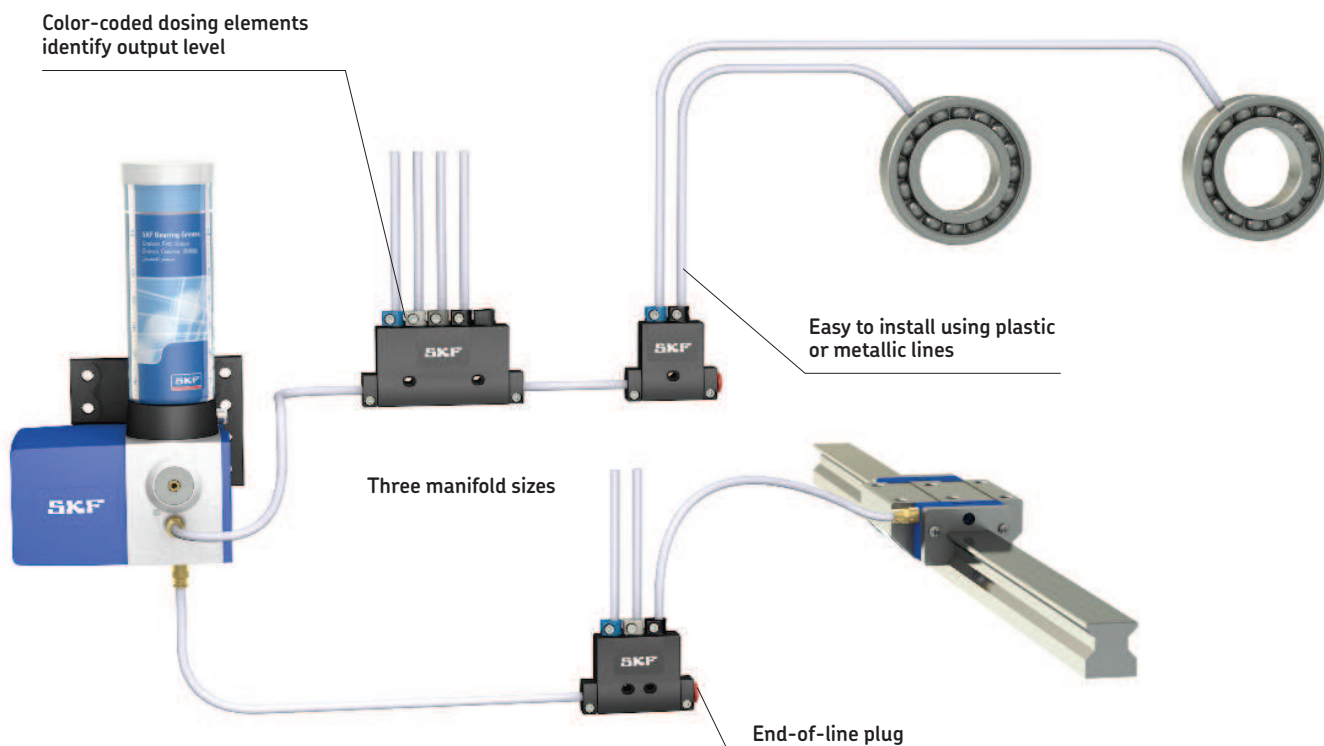

For more information on 310 metering devices, see  
→ [www.skf.com/310](http://www.skf.com/310)  
→ brochure PUB LS/P2 17505 EN

# Choose the right lubricant for your application

SKF single-line systems are available for all types of lubricants: oil, fluid and hard grease. Selecting the right lubricant for your application can be a differentiator in terms of productivity and environmental impact. The ECP and 310 metering devices are designed for use with either oil or fluid grease. Both lubricant types prevent crush and excessive abrasion on linear guides or bearings.



## Oil

Oils are measured in viscosity. The viscosity is an expres-

sion of a fluid's internal friction. Oils are classified in ISO VG viscosity classes from 2 to 3 200. Different types of oils are available, including mineral oils, organic oils and synthetic oils. A compatibility check is recommended prior to using any oil with SKF lubrication systems.

### Features:

- Removal of waste, pollution, abrasive wear
- Oil distribution at low pressures possible, lower system pressures required
- Eligible for high rotating speeds
- Damping of vibrations
- Cooling effect (heat dissipation) at the lubrication points
- Removal of condensate and process water
- Protection against corrosion
- No solidification



## Fluid grease

Greases are more consistent lubricants measured in

NLGI classes. Fluid greases are softer greases in NLGI class 000, 00 and 0. Fluid greases are a mixture of a base oil as lubricating fluid, a thickening agent and additives. A compatibility check is recommended prior to using any fluid grease with SKF lubrication systems.

### Features:

- Creates better sealing effect of the bearing against external influences
- For use with lower rotating speeds
- No dripping of lubricant, good adherent properties, less lubricant waste
- Longer maintenance of lubrication film, therefore less lubricant usage
- Longer machine coolant lifetime, due to less contamination through lubricant
- Less lubricant spillage helps to increase worker safety by reducing risk of slips and falls
- Higher protection against corrosion

## Lubricant expertise

Selecting the right lubricant can be a delicate process. Production processes and raw materials greatly influence lubricant properties and performance. It is virtually impossible to select or compare lubricants based only on their composition. Therefore, performance tests are needed to provide crucial information. In its 100-plus years, SKF has accrued vast knowledge about the interaction of lubricants, materials and surfaces. For more information, contact your local SKF partner.

As pioneers in automatic lubrication systems and with its extensive experience in the machine tool industry, SKF has selected Zeller+Gmelin Divinol Fluid Grease 00 as the standard medium for ECP cartridges. A proven medium for the machine tool industry, this fluid grease fulfills the requirements of automotive industry standards (e.g. Daimler DBL 6833).

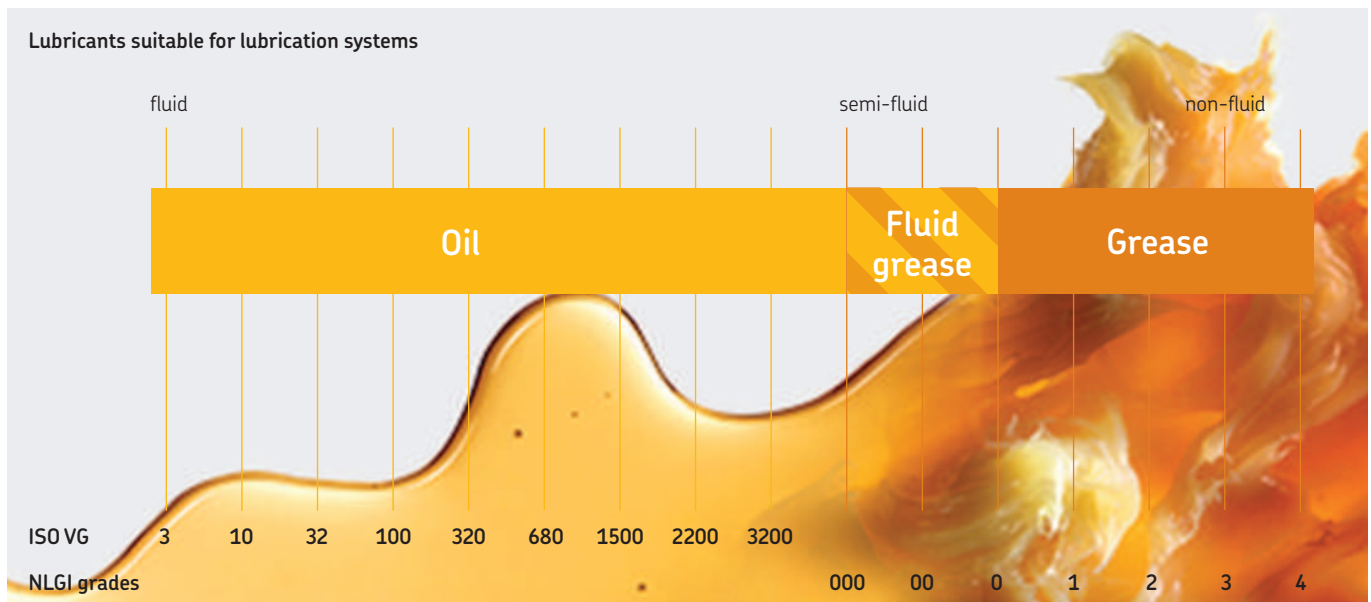



[skf.com](https://skf.com) | [skf.com/lubrication](https://skf.com/lubrication) | [skf.com/ecp](https://skf.com/ecp)

© SKF and Lincoln are registered trademarks of the SKF Group.

© SKF Group 2018

The contents of this publication are the copyright of the publisher and may not be reproduced (even extracts) unless prior written permission is granted. Every care has been taken to ensure the accuracy of the information contained in this publication but no liability can be accepted for any loss or damage whether direct, indirect or consequential arising out of the use of the information contained herein.

**PUB LS/P2 15966|1 EN** · September 2018

Certain image(s) used under license from Shutterstock.com.